

High-Limit LED must be installed as shown (lower 4 pins)

12V Light (White 2-Pin)

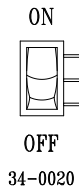

SYSTEM FUSE

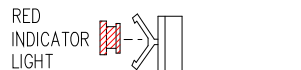

HIGH-LIMIT

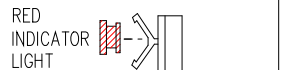

PUMP 1 FUSE

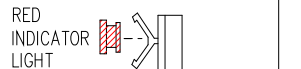

PUMP 2 FUSE

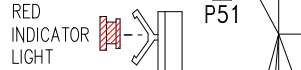

AIR BLOWER FUSE

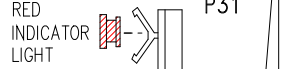

PUMP 3 FUSE

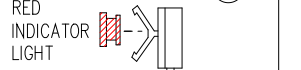

OZON/CIRC. FUSE

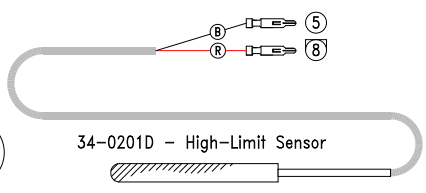
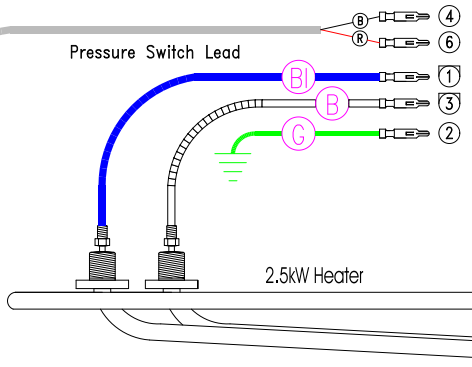
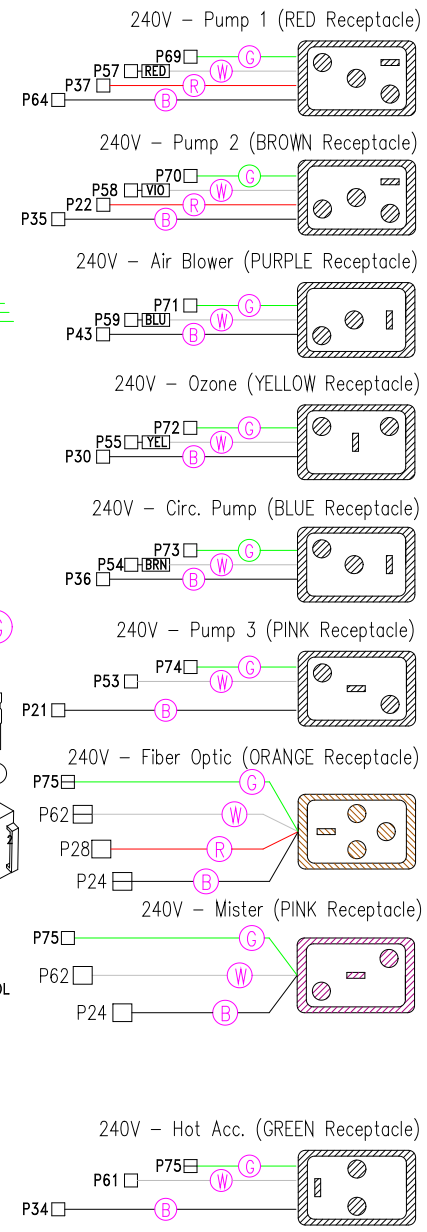
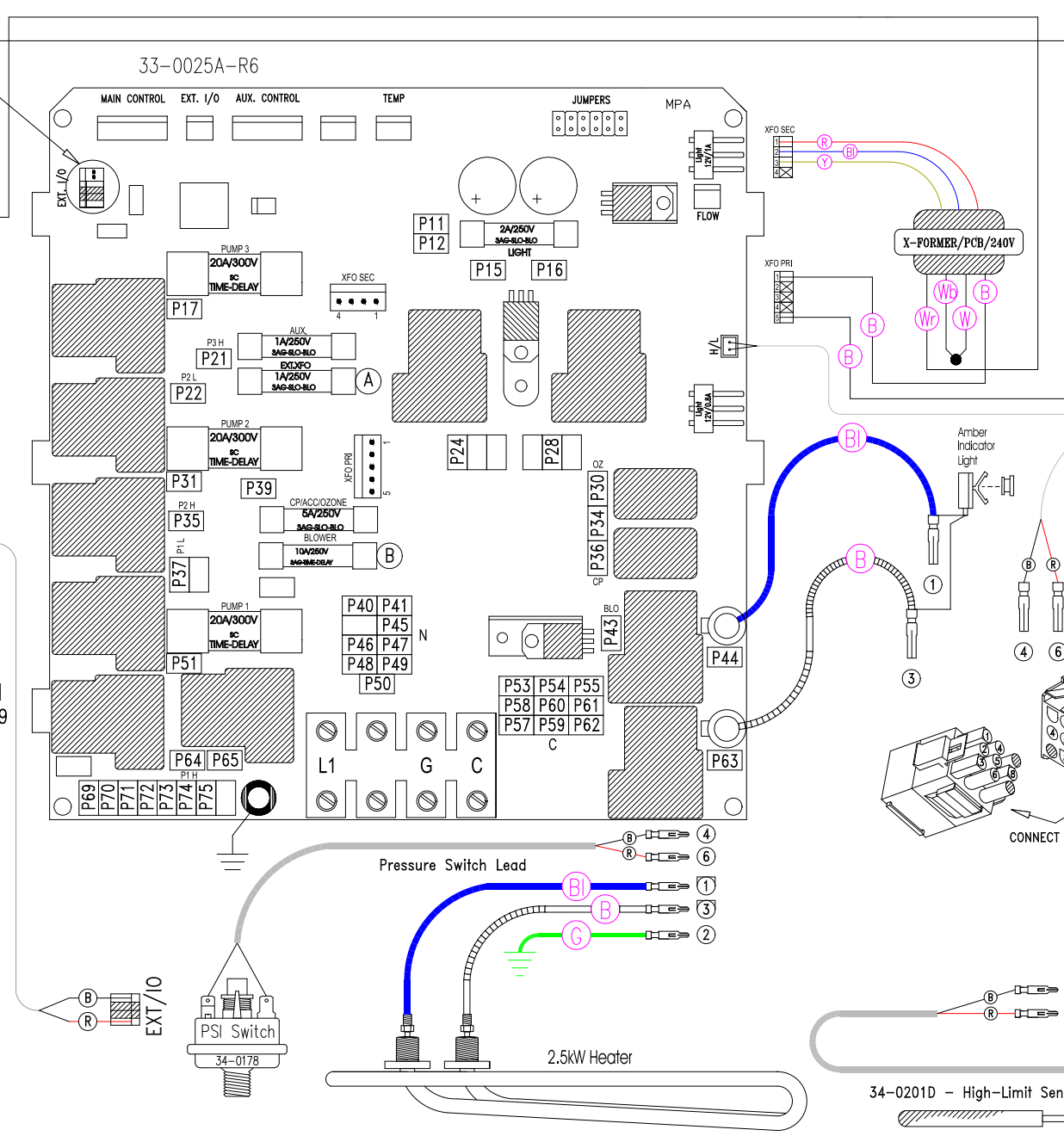
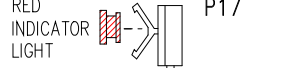

HYDRO-QUIP
CORONA, CA (909) 273-7575

Manufacture Notes:

Approved By:

Dwg. No.
D7222A0-KMP

Drawn
BH
Rev
5

Wire Color Code

Dual Heater Connection: Standard Heater Connected at Factory.

For Remote Heater: Disconnect Factory Installed Heater at 9-Pin Connection. Install Remote Heater Bracket and Secure 9-Pin Receptacle. Connect Remote Heater Externally.

Date
12.15.03
Diagram No.
6703

B - Black
Br - Brown
R - Red
O - Orange
Y - Yellow
G - Green
Bl - Blue
V - Violet
W - White
Gr - Gray